

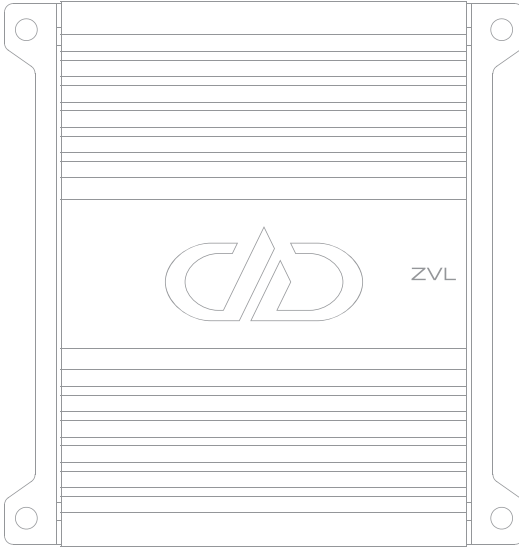

ZVL

OWNER'S MANUAL

SECTIONS



Page 3 Technical Specifications

Page 4 Control Panel Connections

Page 5 RCA Panel Connections

Page 6 Internal Jumper Configuration

Page 7 Input Jumpers

Page 8 Connecting a Remote Control

Page 9 Linking Subwoofer Amplifiers w/ a ZVL input

Page 12 Linking Subwoofer Amplifiers w/out a ZVL input

Page 15 Strapping Subwoofer Amplifiers w/ a ZVL input

Page 17 Strapping Subwoofer Amplifiers w/out a ZVL input

Page 20 Linking Multiple ZVL Modules

Page 21 Connecting Subwoofer Amplifiers and Full Range Amplifiers to a ZVL

Page 21 Using the ZVL as an active RCA distribution block

INTRODUCTION



!!WARNING!!

Severe Amplifier and Subwoofer damage can result from improper installation and setup of the ZVL. PLEASE take time to read this manual carefully and contact a DD Audio technician if you have any questions.

Thank you for purchasing the DD Audio ZVL (Vari-Link). The ZVL is a Multi-Amp Sync Module that can take the place of several separate components commonly used when setting up multi amp systems, making wiring your installs easier and cleaner.

The ZVL can be simultaneously used as a master volume and preamp controller for multiple sub amps and an active RCA distribution module for full range amps. Multiple ZVL units can be linked together when more outputs are needed.

The ZVL can be used with any amplifier but it was engineered to work seamlessly with DD Audio Amps equipped with a ZVL INPUT. To ensure ease of use and proper setup please take a moment to thoroughly read through this manual. We hope you thoroughly enjoy this product, and if you have any questions regarding installation or setup please contact the DD Audio technical support team.

DESIGN FEATURES

- Subwoofer Preamp
 - Gain
 - Variable 24dB/Oct Subsonic Filter
 - Variable 24dB/Oct Low Pass Filter
- 2 channels of input / 10 channels of output
- Remote volume control of subwoofer amp(s)
(with compatible DD Audio amp remote, not Included)
- Remote monitoring of amplifier clipping and voltage
(with compatible DD Audio amp and amp remote, not included)
- Selectable Link, Strap, Preamp and Pass-Through modes
- Aluminum Chassis

TECHNICAL SPECIFICATIONS

ZVL	
Operating Voltage	9V-16V
Input Channels	2
Output Channels	10
RCA Input Sensitivity	0.2-8V
RCA Input Impedance	20K Ω
RCA Output Voltage	8V
RCA Output Impedance	$\geq 100\Omega$
RCA Input S/N	$\geq 105\text{dBA}$
RCA Input THD	$< 0.1\%$
REM OUT Output Current	12V >500mA
Frequency Response	10Hz-25kHz
Low Pass Filter	20Hz-200Hz 24dB/Oct
SubSonic Filter	10Hz-50Hz 24dB/Oct
Power Draw	200mA
Recommended Fuse Rating	1 Amp
Dimensions in	4 x 5 x 2
Dimensions mm	98 x 125 x 47

CONTROL PANEL CONNECTIONS

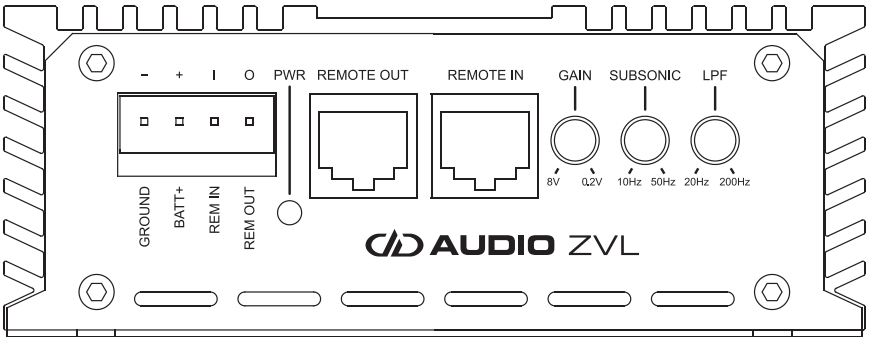

GND:

Connect to a verified chassis ground. Run a separate ground wire vs connecting it to a factory ground wire. Factory ground wires usually have multiple devices connected to them and are not recommended because this can lead to ground loop issues.

BATT+:

Connect to a constant positive power supply within the operating input voltage range. Direct connection to the vehicle's battery is preferred.

REM IN:

Connect to a switched +12V turn-on source to turn the ZVL on and off. No connection is required if using auto turn on. Remove the Turn On Selection Jumper to disable auto turn on when this turn on method is desired.

REM OUT:

Provides a >500mA @ 12v switched turn-on signal for connected amplifiers or other connected components. May require an additional relay for multi component turn-on.

PWR:

When the LED is illuminated it means the ZVL is on.

REMOTE OUT:

Port for connecting the ZVL to a DD Audio amplifier's REMOTE port via modular cable.

REMOTE IN:

Port for connecting a compatible DD Audio amp remote to the ZVL via modular cable.

GAIN:

Adjust the GAIN to match the inputs of the ZVL to the outputs of your signal source.

SUBSONIC:

Adjusting the SUBSONIC control sets the desired subsonic filter point to remove low frequencies that are unwanted or below the sub enclosure's tuning. To avoid subwoofer damage from over excursion it is very important to properly set your subsonic filter when using the ZVL.

LOW PASS:

Adjusting the LOW PASS control sets the desired low pass filter point to remove high range frequencies that are unwanted.

RCA PANEL CONNECTIONS

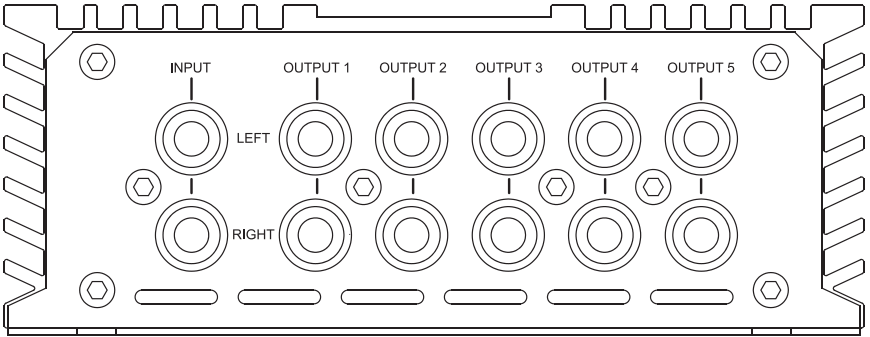

INPUT:
Connect to RCA (line level) signal source.

OUTPUT 1-5:
Connect to RCA (line level) inputs of your amplifier/s via RCA interconnect cables.

INTERNAL JUMPER CONFIGURATION

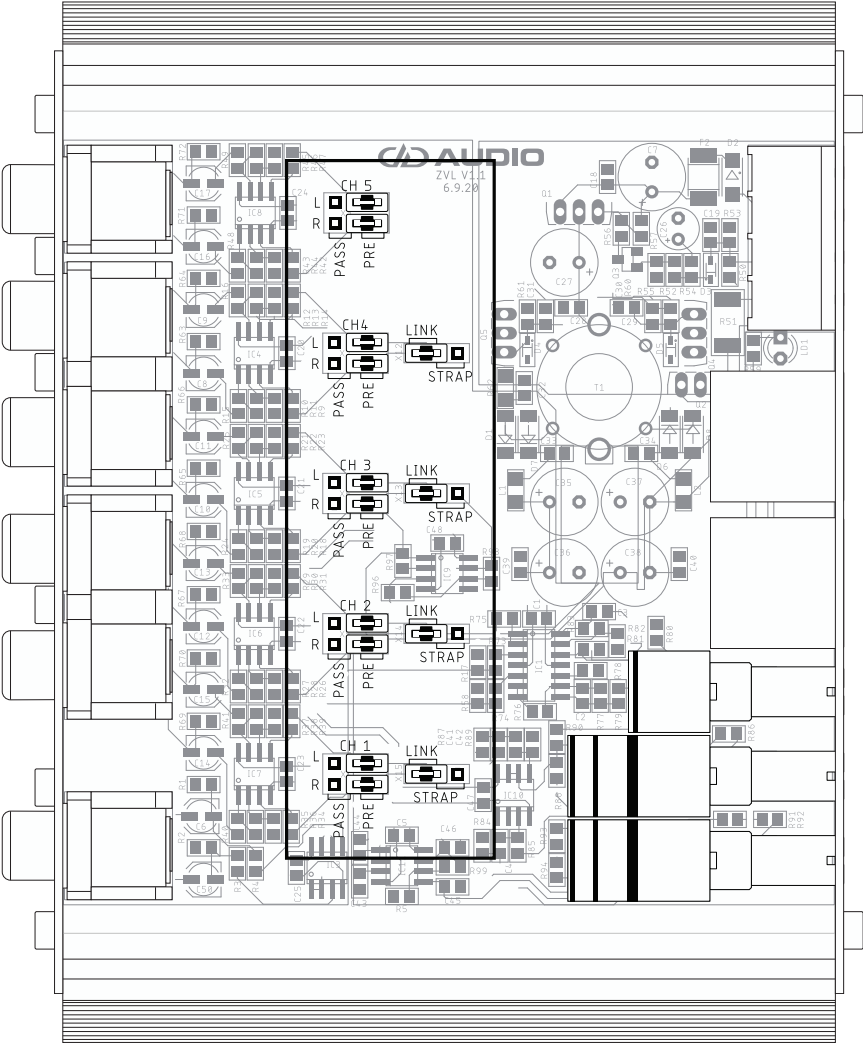

INPUT JUMPERS

PRE:

Passes the input signal from the source unit through the ZVL's subwoofer preamp (GAIN, SUBSONIC, LFP) before sending it to the outputs.

PASS:

Passes the input signal from the source unit directly to the outputs with no effect from the ZVL's subwoofer preamp. This will be used for full range signal distribution.

Pre Input

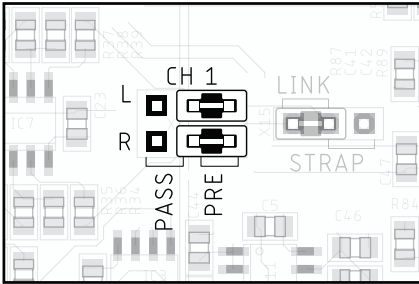

Pass Input

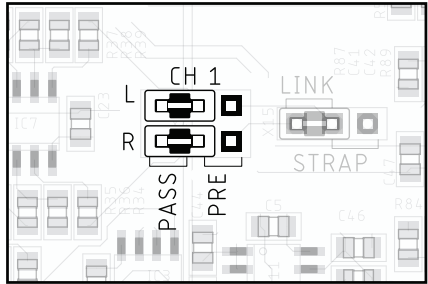

OUTPUT JUMPERS

LINK:

Output pairs will be in phase with each other. This will be the most common output setting for the majority of applications including full range pass through. See **Linking Subwoofer Amplifiers** diagrams for proper Link mode wiring.

STRAP:

Converts the left and right channels of output channels (1,2,3,4) from in phase to 180 degrees out of phase from each other. This setting is only used when configuring pairs of subwoofer amplifiers in Strap mode. Channel pair 5 is permanently set to Link mode. See the **Strapping Subwoofer Amplifiers** diagrams for proper strap mode wiring.

Link Output

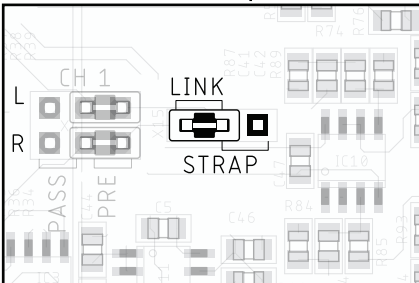

Strap Output

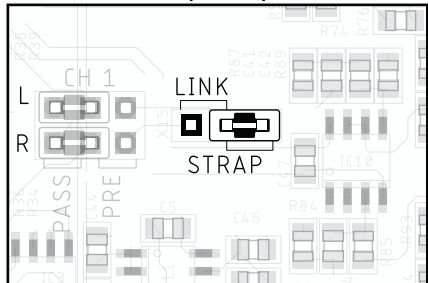

CONNECTING A REMOTE CONTROL

The ZVL works with compatible DD Audio amplifier remote control knobs giving you the ability to monitor voltage and clipping and control the master volume of linked/strapped sub amps. In most cases, the remote control that comes with your DD Audio amplifier will be compatible with the ZVL and you can simply follow the connection instructions below.

1. Run the cable provided with your remote control from the remote control to the REMOTE IN on the ZVL.
2. Run the cable provided with the ZVL from the REM OUT of the ZVL to the REMOTE port on your main amplifier

If you are using an older DD Audio amplifier or a non DD Audio amplifier you can still purchase a ZVL compatible remote control that will give you the ability to control the master volume of linked/strapped sub amps.

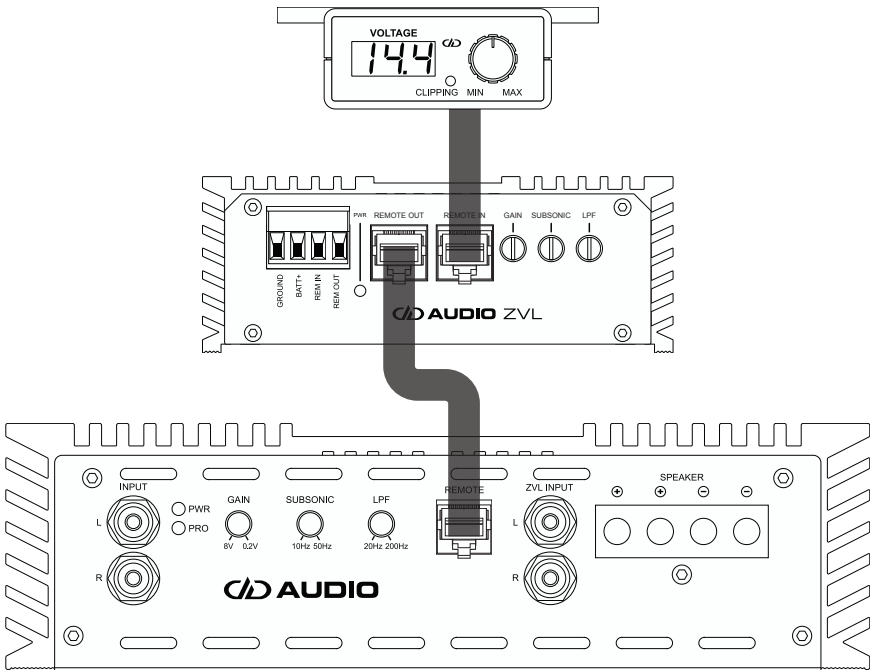

COMPATIBLE REMOTES

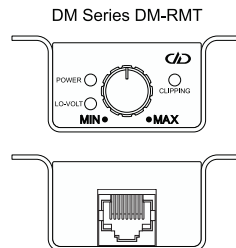
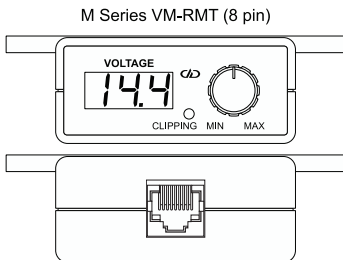

LINKING SUBWOOFER AMPLIFIERS W/ A ZVL INPUT (amplifiers must be matching models)

1. The ZVL default setting is channel pairs 1-4 Pre/Link and channel pair 5 Pass/Link. This configuration will simultaneously control 4 sub amps in LINK mode while passing full range signal on channel pair 5.
2. If no jumper reconfiguration is needed, proceed to step 5. If jumper reconfiguration is needed, remove the backplate to access the internal jumpers and proceed to step 3.
3. Set the internal output jumpers to the **LINK** position for the channels you will be connecting to the amplifiers.
4. Set the internal input jumpers to the **PRE** position for the channels you will be connecting to the linked sub amplifiers. This will route the signal through the ZVL preamp controls. Reassemble the ZVL then proceed.
5. Connect the full range RCA outputs from the source unit to the ZVL inputs.
6. Connect the RCAs from the ZVL outputs, as shown in the linking diagram, to your DD Audio Amp's ZVL inputs.
7. By connecting to the amplifier's ZVL inputs you will bypass all controls on the amplifier's preamp so there will be no need to adjust the pre amp controls on the amp.
8. Connect a speaker (+) POSITIVE LEAD to the (+) POSITIVE TERMINAL of the amplifier. Connect the speaker (-) NEGATIVE LEAD to the (-) NEGATIVE TERMINAL of the amplifier.
9. Repeat the connection process for each amplifier you are Linking with the ZVL.
10. The GAIN control on the ZVL should be set to match the output signal voltage from your Source Unit.
11. Adjust the ZVL LOW PASS FILTER and SUBSONIC FILTER for desired listening.

NOTE: Up to 5 amplifiers can be linked in this manner with one ZVL. If more outputs are required for your application you will be able to connect 4 amplifiers while using Channel 5/6 to feed signal into a second ZVL unit allowing you to link up to 9 amplifiers in this manner with 2 ZVLs. Please refer to the **Linking Multiple ZVL's** section of this manual.

LINKING SUBWOOFER AMPLIFIERS W/ A ZVL INPUT

(amplifiers must be matching models)

[continued]

SET JUMPERS FIRST, see ZVL Internal Jumper Configuration on next page →

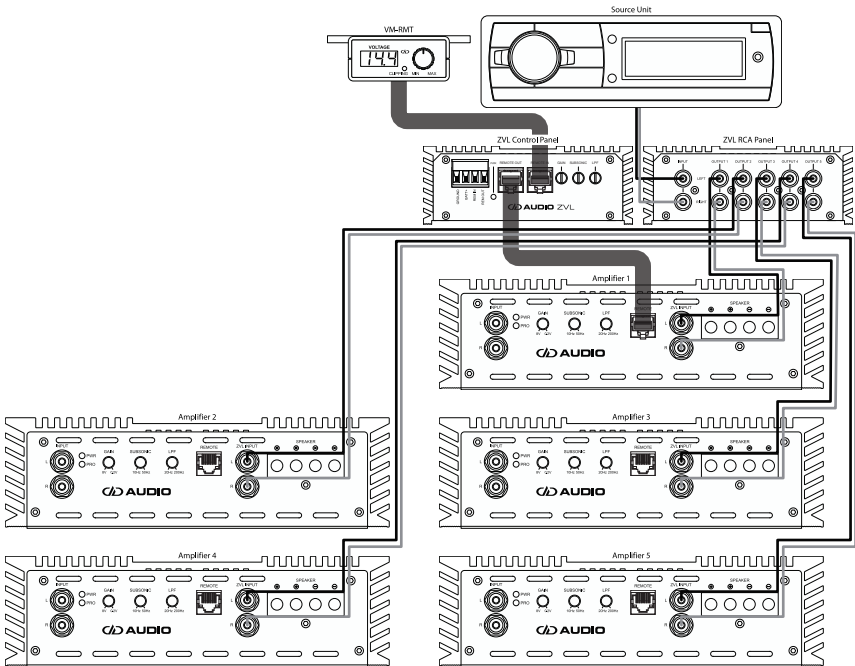

!!WARNING!!

Severe Amplifier and Subwoofer damage can result from improper installation and setup of the ZVL. PLEASE take time to read this manual carefully and contact a DD Audio technician if you have any questions.

LINKING SUBWOOFER AMPLIFIERS W/ A ZVL INPUT

(amplifiers must be matching models)

[continued]

ZVL Internal Jumper Configuration

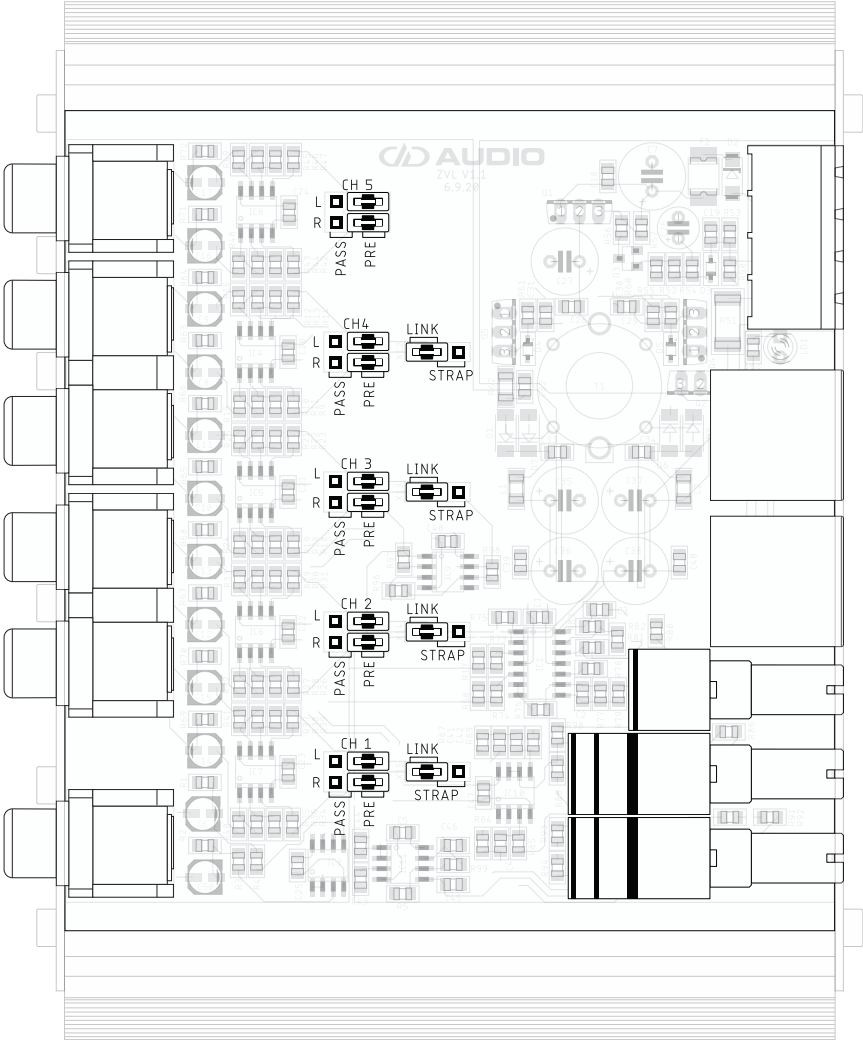

LINKING SUBWOOFER AMPLIFIERS W/OUT A ZVL INPUT

(amplifiers must be matching models)

[continued]

1. The ZVL default setting is channel pairs 1-4 Pre/Link and channel pair 5 Pass/Link. This configuration will simultaneously control 4 sub amps in LINK mode while passing full range signal on channel pair 5.
2. If no reconfiguration is needed, proceed to step 5. If reconfiguration is needed, remove the backplate to access the internal jumpers and proceed to step 3.
3. Set the internal output jumpers to the **LINK** position for the channels you will be connecting to the linked amplifiers.
4. Set the internal input jumpers to the **PRE** position for the channels you will be connecting to the linked amplifiers. This will route the signal through the ZVL preamp controls. Reassemble the ZVL then proceed.
5. Connect the full range RCA outputs from the source unit to the ZVL inputs.
6. Connect the RCAs from the ZVL output, as shown in the linking diagram, to your DD Audio Amp's ZVL INPUT.
7. The amplifier settings need to be adjusted as follows: The GAIN should be adjusted to the lowest setting. The LOW PASS FILTER should be turned towards the highest frequency. (EXAMPLE: if LPF = 20Hz to 200Hz, adjust to 200Hz) - The SUBSONIC FILTER should be turned towards the lowest frequency. (EXAMPLE: if SUBSONIC range = 10Hz to 50Hz, adjust to 10Hz) - If applicable set preamp to MASTER or MAIN - any other amplifier settings such as PHASE or BASS BOOST should be set to 0.
8. Set the GAIN control on the ZVL to half.
9. The ZVL LPF should be set to its highest frequency setting and the SUBSONIC should be set to its lowest frequency setting.
10. Now you will need to match the outputs of your amplifiers. For this procedure you will need a Digital Voltmeter and the ability to play a 0dB 40hz test tone from your source unit.
 - a. Determine your target output voltage using the formula $\sqrt{P \times R} = E$. Multiply the RMS Power of your amplifier (P) by the impedance of the load that will be connected to the amplifier (R), then find the square root of that number to get the target output Voltage (E). (EXAMPLE: 2000W (P) with a 1Ω load (R) would equal 44.7 VAC (E)) $\sqrt{2000 \times 1} = 44.7 \text{VAC}$
 - b. Make sure no subwoofers are connected to the amplifiers.
 - c. Adjust your Voltmeter so that it is measuring Volts AC.
 - d. Connect the positive Voltmeter lead to the (+) POSITIVE TERMINAL on amplifier then connect the negative Voltmeter lead to the (-) NEGATIVE TERMINAL on amplifier.
 - e. Turn the audio system on and turn the source unit volume all the way down.
 - f. Now, while playing the 40Hz sine wave turn your source unit to its maximum clean volume level. If you don't have an oscilloscope or other tools to determine this, you can just turn your source unit up to $\frac{3}{4}$ of its volume for this step.

LINKING SUBWOOFER AMPLIFIERS W/OUT A ZVL INPUT [continued]

(amplifiers must be matching models)

- g. While measuring the Voltage AC turn the amplifier's gain up until you reach your target output voltage.
 - h. Repeat steps d-g for all the linked amplifiers until all are set to the target output voltage.
 - i. Turn your system off.
11. Connect the speaker (+) POSITIVE LEAD to the (+) POSITIVE TERMINAL of the amplifier. Connect the speaker (-) NEGATIVE LEAD to the (-) NEGATIVE TERMINAL of the amplifier.
 12. Repeat the connection process for each amplifier you are Linking with the ZVL.
 13. Adjust the ZVL LOW PASS FILTER and SUBSONIC FILTER for desired listening.

NOTE: Up to 5 amplifiers can be linked in this manner with one ZVL. If more outputs are required for your application you will be able to connect 4 amplifiers while using Channel 5/6 to feed signal into a second ZVL unit allowing you to link up to 9 amplifiers in this manner. Please refer to the **Linking 2 ZVL's** section of this manual.

SET JUMPERS FIRST, see ZVL Internal Jumper Configuration on next page →

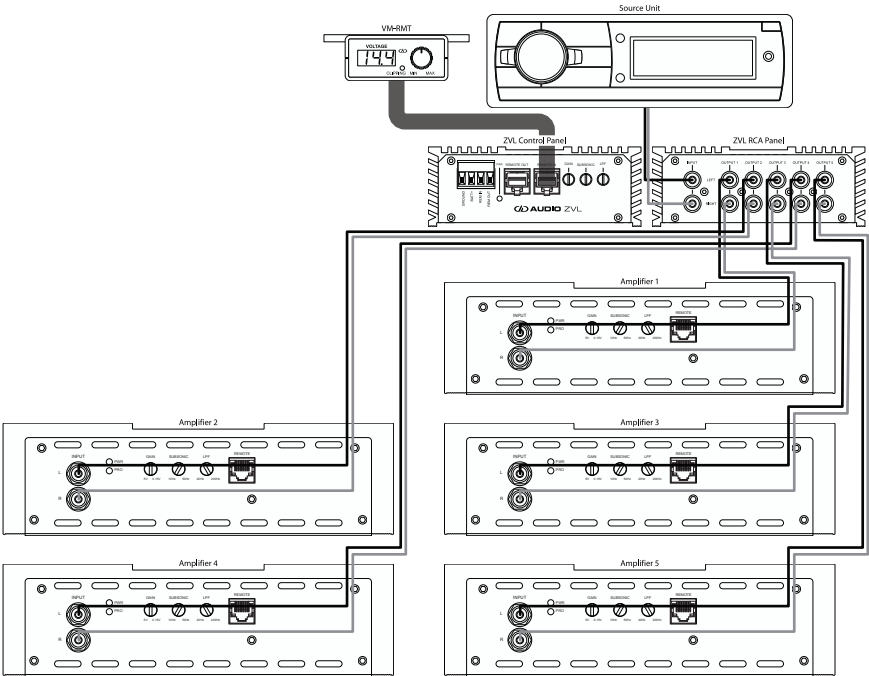

LINKING SUBWOOFER AMPLIFIERS W/OUT A ZVL INPUT
(amplifiers must be matching models) [continued]

ZVL Internal Jumper Configuration

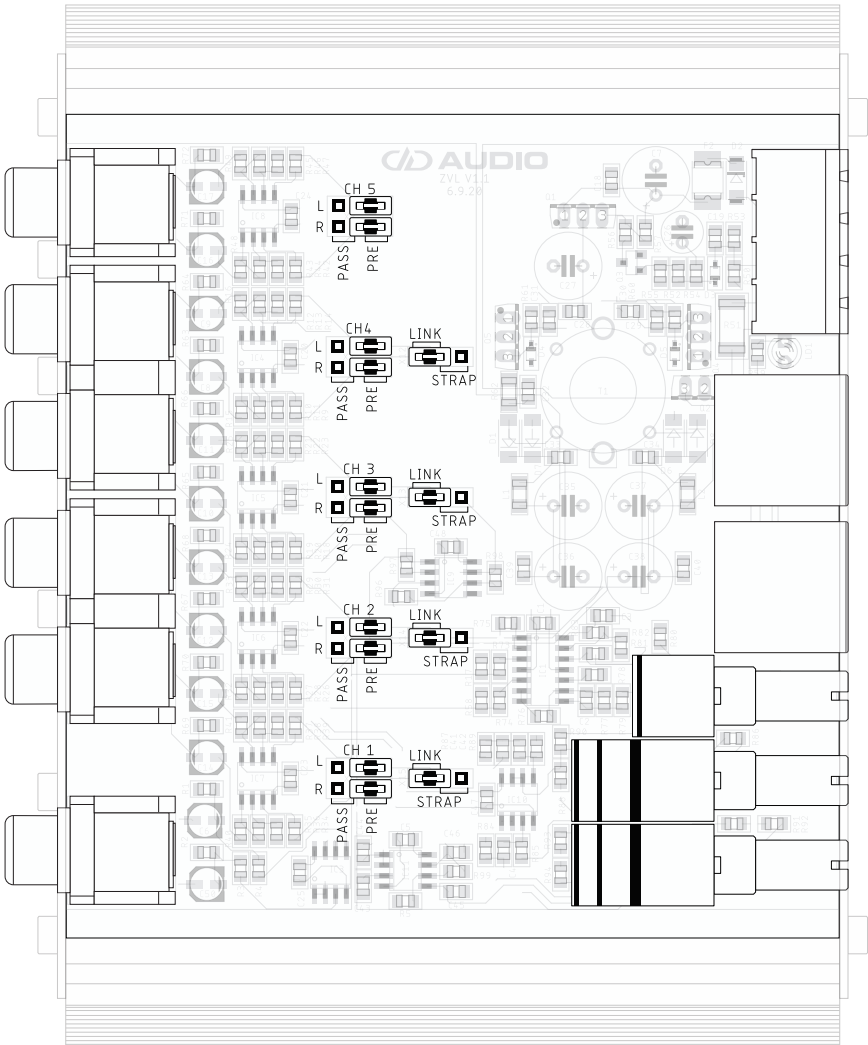

STRAPPING SUBWOOFER AMPLIFIERS W/ A ZVL INPUT (amplifiers must be matching models)

1. Remove the ZVL's backplate and set the internal output jumpers to the **STRAP** position for the channels you will be connecting to the strapped amplifiers.
2. Set the internal input jumpers to the **PRE** position for the channels you will be connecting to the strapped amplifiers. This routes the signal through the ZVL preamp controls. Reassemble the ZVL then proceed.
3. Connect the full range RCA outputs from the source unit to the ZVL inputs.
4. Connect the RCA's from the ZVL OUTPUT as shown in the strapping diagram below to the amplifier's ZVL INPUT.
5. By connecting to the amplifier's ZVL inputs you will bypass all controls on the amplifier's preamp so there will be no need to adjust the controls on the amp.
6. Connect a strapping wire between the (-) NEGATIVE TERMINALS of the two amplifiers being strapped.
7. Connect the speaker (+) POSITIVE LEAD to the (+) POSITIVE TERMINAL of amplifier #1. Connect the speaker (-) NEGATIVE LEAD to the (+) POSITIVE TERMINAL of amplifier #2. Repeat the connection process for each pair of amplifiers you are strapping with the ZVL.
8. The GAIN control on the ZVL should be be set to match the output signal voltage from your Source Unit.
9. The ZVL LOW PASS FILTER and SUBSONIC FILTER should be adjusted for desired listening.

SET JUMPERS FIRST, see ZVL Internal Jumper Configuration on next page →

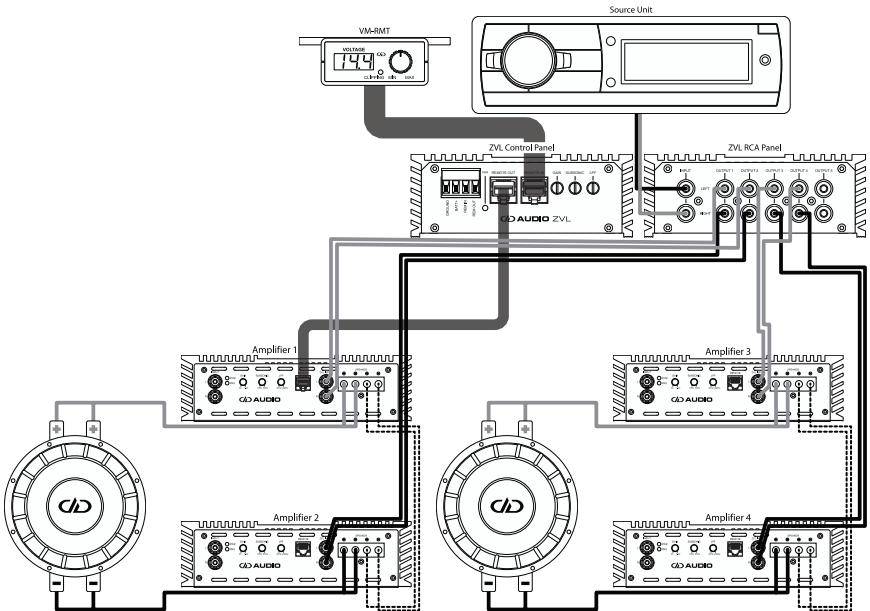

STRAPPING SUBWOOFER AMPLIFIERS W/ A ZVL INPUT

(amplifiers must be matching models) [continued]

ZVL Internal Jumper Configuration

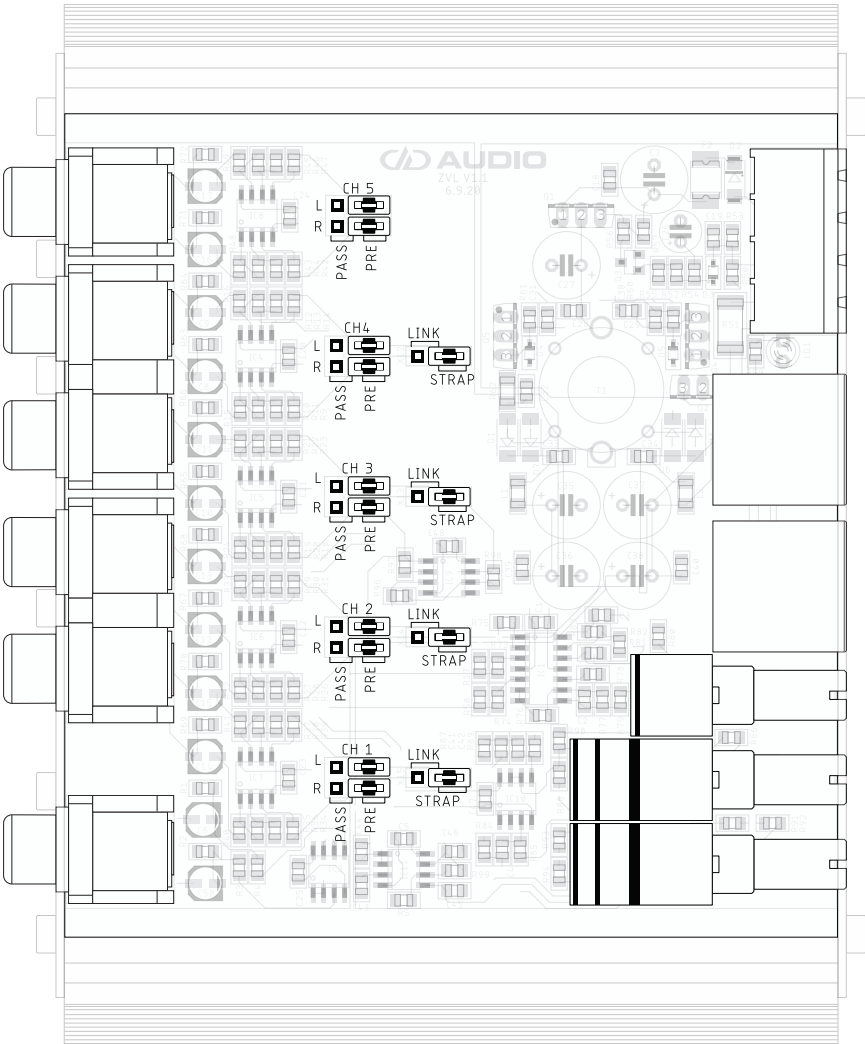

STRAPPING SUBWOOFER AMPLIFIERS W/OUT A ZVL INPUT (amplifiers must be matching models)

1. Remove the ZVL's backplate and set the internal output jumpers to the **STRAP** position for the channels you will be connecting to the strapped amplifiers.
2. Set the internal input jumpers to the **PRE** position for the channels you will be connecting to the strapped amplifiers. This routes the signal through the ZVL preamp controls.
3. Reassemble the ZVL then proceed.
4. Connect the full range RCA outputs from the source unit to the ZVL inputs.
5. Connect the RCA's from the ZVL OUTPUTS as shown in the strapping diagram below to the amplifier INPUTS.
6. The amplifier settings need to be adjusted as follows: The GAIN should be adjusted to the lowest setting. The LOW PASS FILTER should be turned towards the highest frequency (EXAMPLE: if LPF = 20Hz to 200Hz, adjust to 200Hz). The SUBSONIC FILTER should be turned towards the lowest frequency (EXAMPLE: if SUBSONIC range = 10Hz to 50Hz, adjust to 10Hz). If applicable set preamp to MASTER or MAIN. Any other amplifier settings such as PHASE or BASS BOOST should be set to 0.
7. Set the GAIN control on the ZVL to half.
8. The ZVL LPF should be set to its highest frequency setting and the SUBSONIC should be set to its lowest frequency setting.
9. Now you will need to match the outputs of your amplifiers. For this procedure you will need a Digital Voltmeter and the ability to play a 0dB 40hz test tone from your source unit.
 - a. Determine your target output voltage by adding the RMS wattage of your amplifiers to get a combined/total RMS wattage. Next, use the following formula to get your combined target voltage $\sqrt{P \cdot R} = E$. Multiply (P) by the impedance of the load that will be connected to the amplifiers (R), then find the square root of that number to get the target output Voltage (E) (EXAMPLE: Strapping 2 x 2000 watt RMS amps at 2Ω . $4000W (P)$ with a 2Ω load (R) would equal $89.44 VAC (E)$ - ($\sqrt{4000 \cdot 2} = 89.44VAC$). Once you have determined your target output voltage for the pair of strapped amps divide it by 2 ($89.44VAC / 2 = 44.72VAC$). This gives you the individual target voltage for each amp.
 - b. Make sure no subwoofers are connected to the amplifiers.
 - c. Adjust your Voltmeter so that it is measuring Volts AC.
 - d. Connect the positive voltmeter lead to the (+) POSITIVE TERMINAL on amplifier #1. Connect the negative voltmeter lead to the (-) NEGATIVE TERMINAL on amplifier #1.
 - e. Turn the audio system on and turn the source unit volume all the way down.
 - f. Now, while playing the 40Hz sine wave turn your source unit to its maximum clean volume level. If you don't have an oscilloscope or other tools to determine this, you can just turn your source unit up to $\frac{3}{4}$ of its volume for this step.
 - g. Turn amplifier #1's gain up until your voltmeter reads the individual target output voltage. Now connect the voltmeter to the speaker terminals of amplifier #2 and adjust the gain of amplifier #2 until you see the exact same voltmeter reading.

STRAPPING SUBWOOFER AMPLIFIERS W/OUT A ZVL INPUT [continued]

- h. Connect a strapping wire between the (-) NEGATIVE TERMINALS of the two amplifiers being strapped.
 - i. Connect the positive voltmeter lead to the (+) POSITIVE TERMINAL on amplifier #1. Connect the negative voltmeter lead to the (+) POSITIVE TERMINAL on amplifier #2. The voltmeter should now read the target voltage for the combined amplifiers.
 - j. Turn your system off.
10. Connect the speaker (+) POSITIVE LEAD to the (+) POSITIVE TERMINAL of amplifier #1. Connect the speaker (-) NEGATIVE LEAD to the (+) POSITIVE TERMINAL of amplifier #2. Repeat the connection process for each pair of amplifiers you are strapping with the ZVL.
11. Adjust the ZVL LOW PASS FILTER and SUBSONIC FILTER for desired listening.

NOTE: Two pairs of amplifiers can be strapped in this manner with one ZVL. If more outputs are required for your application you will be able to use Channel 5/6 to feed signal into a second ZVL unit allowing you to strap up to 4 pairs amplifiers in this manner. Please refer to the **Linking 2 ZVL Modules** section of this manual.

SET JUMPERS FIRST, see ZVL Internal Jumper Configuration on next page →

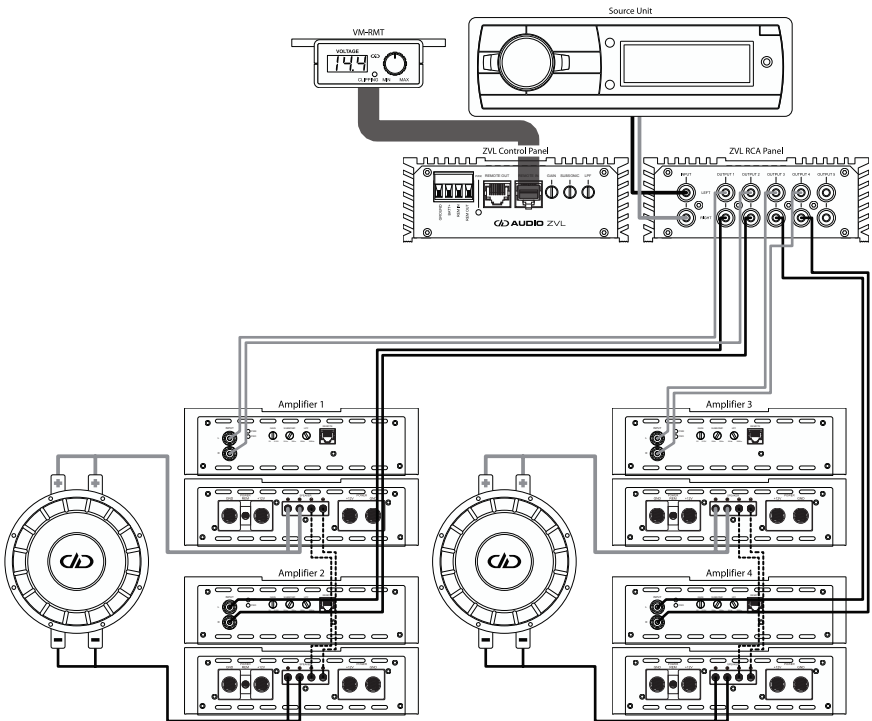

STRAPPING SUBWOOFER AMPLIFIERS W/OUT A ZVL INPUT
(amplifiers must be matching models) [continued]

ZVL Internal Jumper Configuration

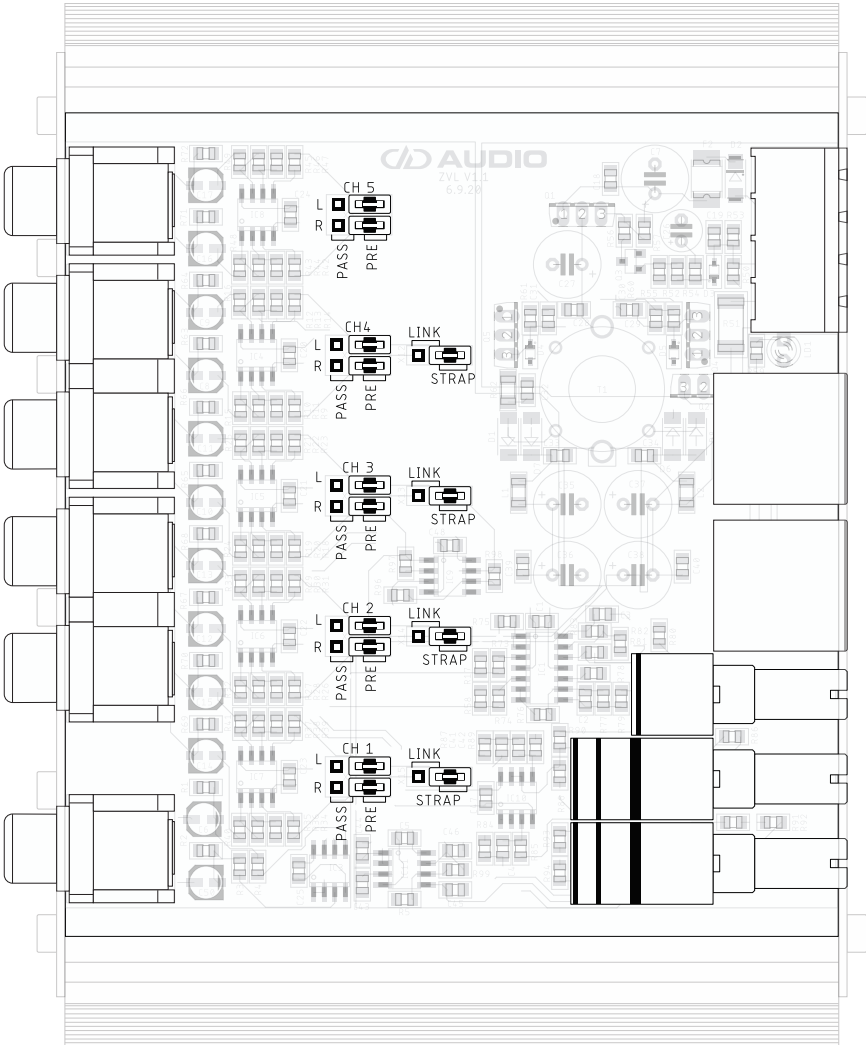

LINKING MULTIPLE ZVL MODULES

By linking 2 ZVL modules together you can expand the number of RCA outputs available for distribution. There is no limit to the number of ZVL modules you can link.

1. If you want ZVL #2 to use the preamp settings from the ZVL #1 for matched control of additional subwoofer amps set CH 5/6 on ZVL #1's internal input jumper to **PRE** and set all of ZVL #2's input jumpers to **PASS**. This will copy the preamp setting from ZVL #1 to all 5 outputs on ZVL #2. This will also allow all 5 output levels from ZVL #2 to be controlled by ZVL #1's remote control.
2. If you want ZVL #2 to use the full range signal from your source unit set CH 5/6 on ZVL #1's internal input jumper to **PASS**. Then configure ZVL #2 as needed.
3. Connect an RCA cable from ZVL #1's CH 5/6 Output to ZVL #2's INPUT.

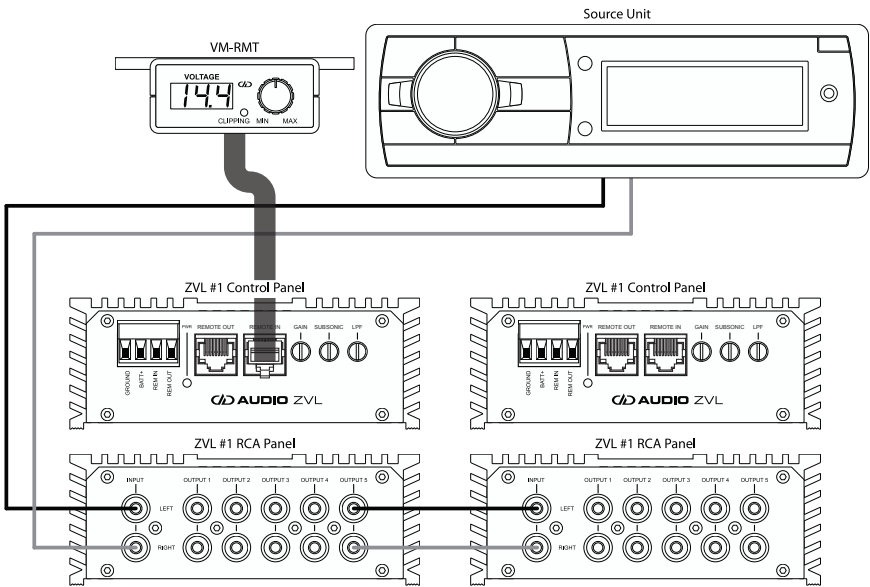

The ZVL can be simultaneously used as a master volume controller and preamp for multiple sub amps, and an active full range signal RCA distribution block.

CONNECTING SUBWOOFER AMPLIFIERS AND FULL RANGE AMPLIFIERS TO A ZVL

If you are using the the ZVL to control multiple linked or strapped subwoofer amps while also distributing full range signal to other amplifiers or processors in the system use the **Internal Jumper Configuration** guide to set the input and output jumpers for your subwoofer amp application then set **all** remaining channel's input jumpers to **PASS** and **all** remaining output jumpers to **LINK**. This will **allow** you to utilize the ZVL preamp section for the subwoofer amplifiers while passing the full range signal from the source unit to the other amplifiers.

USING THE ZVL AS AN ACTIVE RCA DISTRIBUTION BLOCK:

If you are using the ZVL as an RCA distribution block and no subwoofer pre amp control is needed you can simply set **all** internal input jumpers to **PASS** and **all** output jumpers to **LINK**. This will pass the full range signal from the source unit directly to **all** of the outputs. In this configuration the ZVL preamp gain and crossovers will have no effect on the output signal and you will not be able to control output levels with a connected remote control. When an internal preamp jumper is set to **PASS** the ZVL output voltage will be 1:1 with the source unit's output voltage. This **allows** you to distribute RCA signal while eliminating any RCA voltage loss from the source unit.



!!WARNING!!

Severe Amplifier and Subwoofer damage can result from improper installation and setup of the ZVL. PLEASE take time to read this manual carefully and contact a DD Audio technician if you have any questions.

If you have any questions regarding setup, installation or warranty please contact the DD Audio technical support team by email at service@ddaudio.com or by phone at **(405) 239-2800**.

DD
AUDIO

DD AUDIO TRUE TO THE SOURCE.

4025 NW 36th St., Oklahoma City, OK 73112 • (405) 239-2800

DDAUDIO.COM

